

## P-Channel Enhancement Mode MOSFET

### Feature

- -20V/-4.0A,  $R_{DS(ON)} = 60\text{m}\Omega(\text{MAX}) @V_{GS} = -4.5\text{V}$ .  
 $R_{DS(ON)} = 70\text{m}\Omega(\text{MAX}) @V_{GS} = -2.5\text{V}$ .
- Super High dense cell design for extremely low  $R_{DS(ON)}$
- Reliable and Rugged
- ESD Protected
- SC-59 for Surface Mount Package

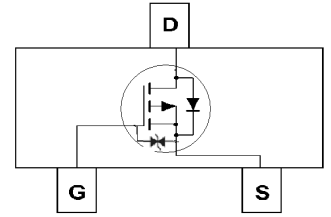

SC-59

### Applications

- Power Management
- Portable Equipment and Battery Powered Systems.

### Absolute Maximum Ratings $T_A=25^\circ\text{C}$ Unless Otherwise noted

Parameter	Symbol	Limit	Units
Drain-Source Voltage	$V_{DS}$	-20	V
Gate-Source Voltage	$V_{GS}$	$\pm 10$	V
Drain Current-Continuous	$I_D$	-4.0	A

### Electrical Characteristics $T_A=25^\circ\text{C}$ Unless Otherwise noted

Parameter	Symbol	Test Conditions	Min	Typ.	Max	Units
<b>Off Characteristics</b>						
Drain to Source Breakdown Voltage	BVDSS	$V_{GS}=0\text{V}, I_D=-250\mu\text{A}$	-20	-	-	V
Zero-Gate Voltage Drain Current	IDSS	$V_{DS}=-20\text{V}, V_{GS}=0\text{V}$	-	-	-1	$\mu\text{A}$
Gate Body Leakage Current, Forward	IGSSF	$V_{GS}=10\text{V}, V_{DS}=0\text{V}$	-	-	10	$\mu\text{A}$
Gate Body Leakage Current, Reverse	IGSSR	$V_{GS}=-10\text{V}, V_{DS}=0\text{V}$	-	-	-10	$\mu\text{A}$
<b>On Characteristics</b>						
Gate Threshold Voltage	$V_{GS(th)}$	$V_{GS}=V_{DS}, I_D=-250\mu\text{A}$	-0.4	-	-1.0	V
Static Drain-source On-Resistance	RDS(ON)	$V_{GS}=-4.5\text{V}, I_D=-4.0\text{A}$	-	35	60	$\text{m}\Omega$
		$V_{GS}=-2.5\text{V}, I_D=-4.0\text{A}$	-	45	70	$\text{m}\Omega$
<b>Drain-Source Diode Characteristics and Maximum Ratings</b>						
Drain-Source Diode Forward Voltage	VSD	$V_{GS}=0\text{V}, I_S=-1.0\text{A}$			-1.2	V

## Typical Characteristics

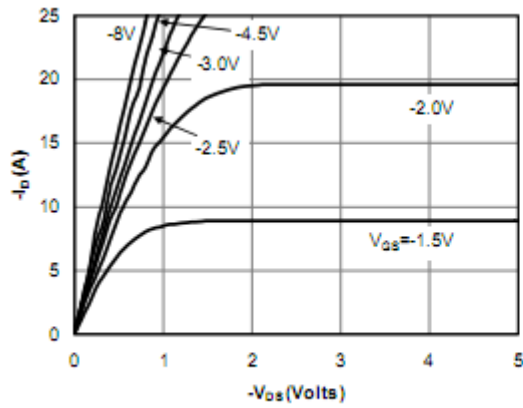

Fig 1: On-Region Characteristics

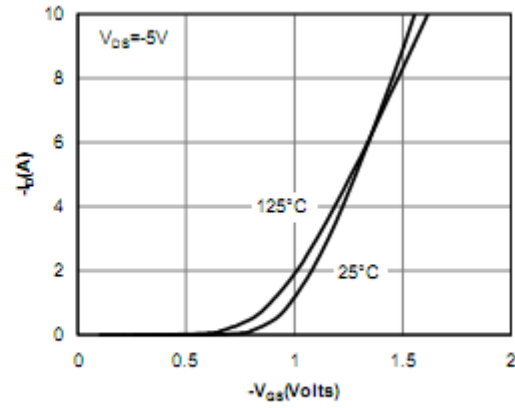

Figure 2: Transfer Characteristics

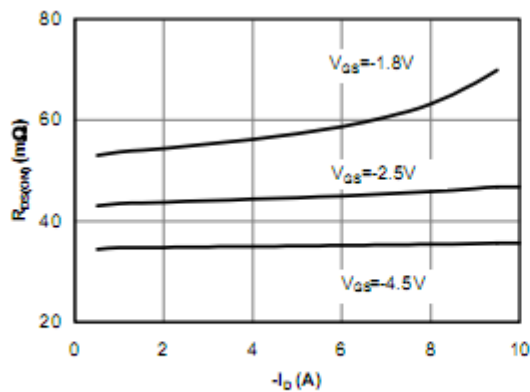

Figure 3: On-Resistance vs. Drain Current and Gate Voltage

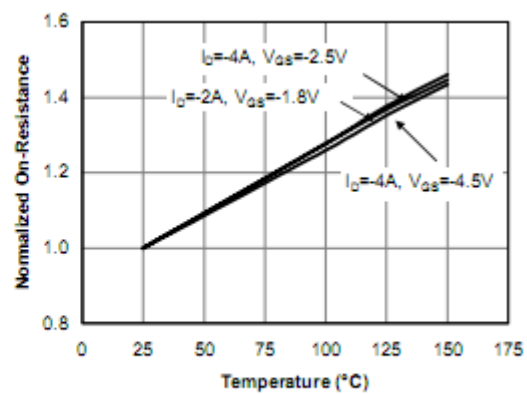

Figure 4: On-Resistance vs. Junction Temperature

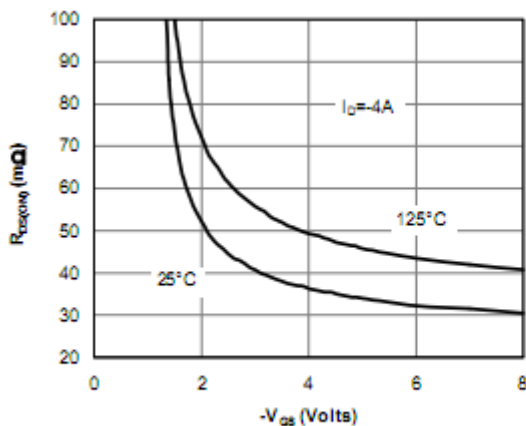

Figure 5: On-Resistance vs. Gate-Source Voltage

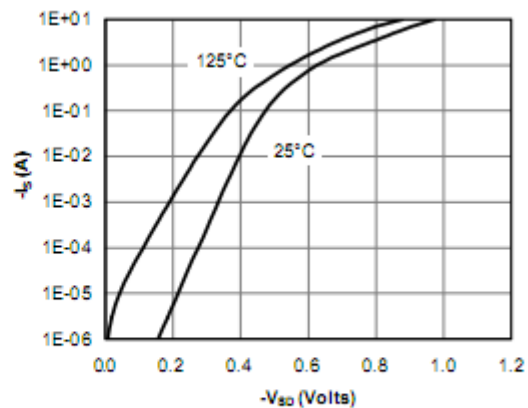

Figure 6: Body-Diode Characteristics

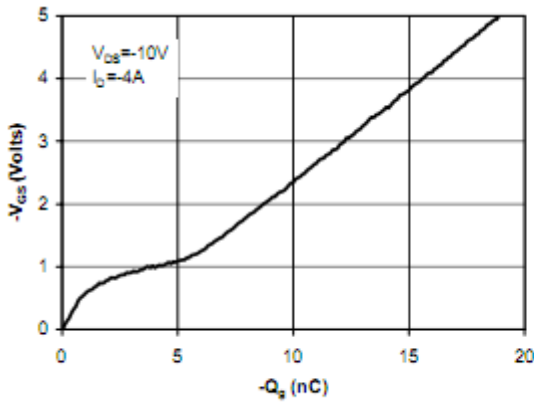

Figure 7: Gate-Charge Characteristics

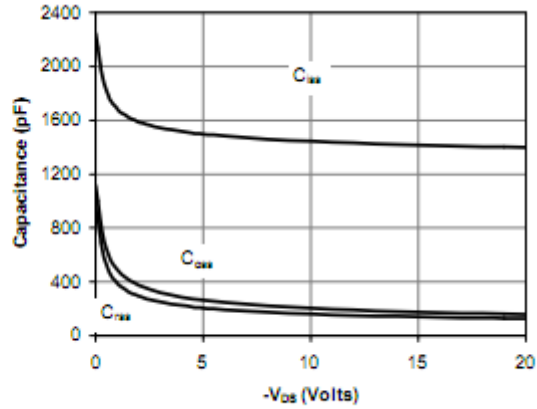

Figure 8: Capacitance Characteristics

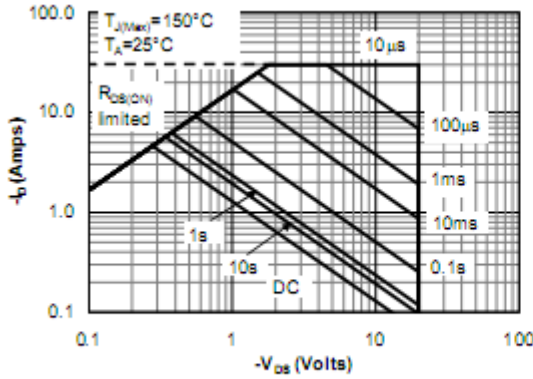

Figure 9: Maximum Forward Biased Safe Operating Area (Note E)

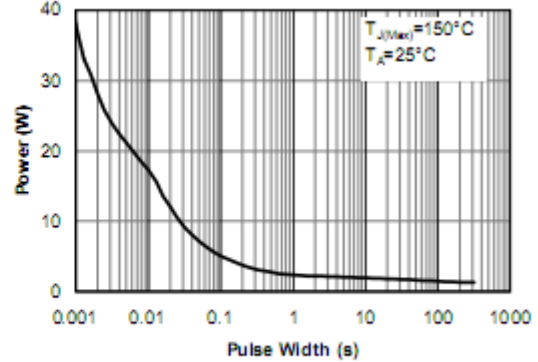

Figure 10: Single Pulse Power Rating Junction-to-Ambient (Note E)

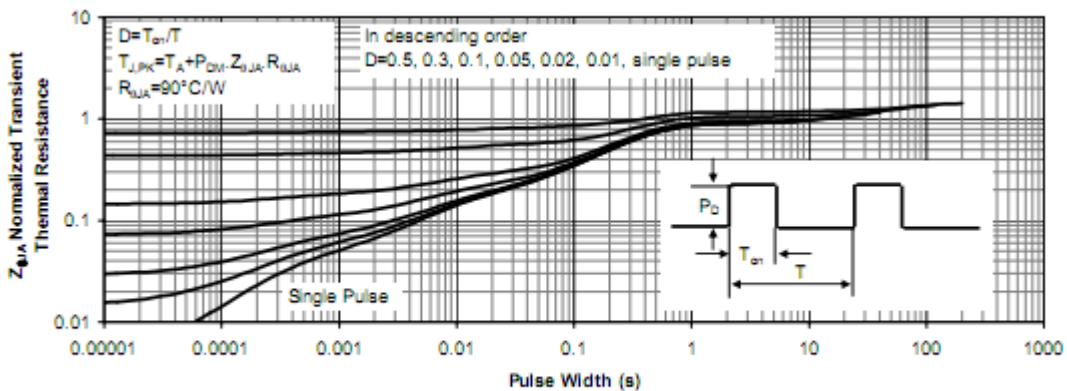
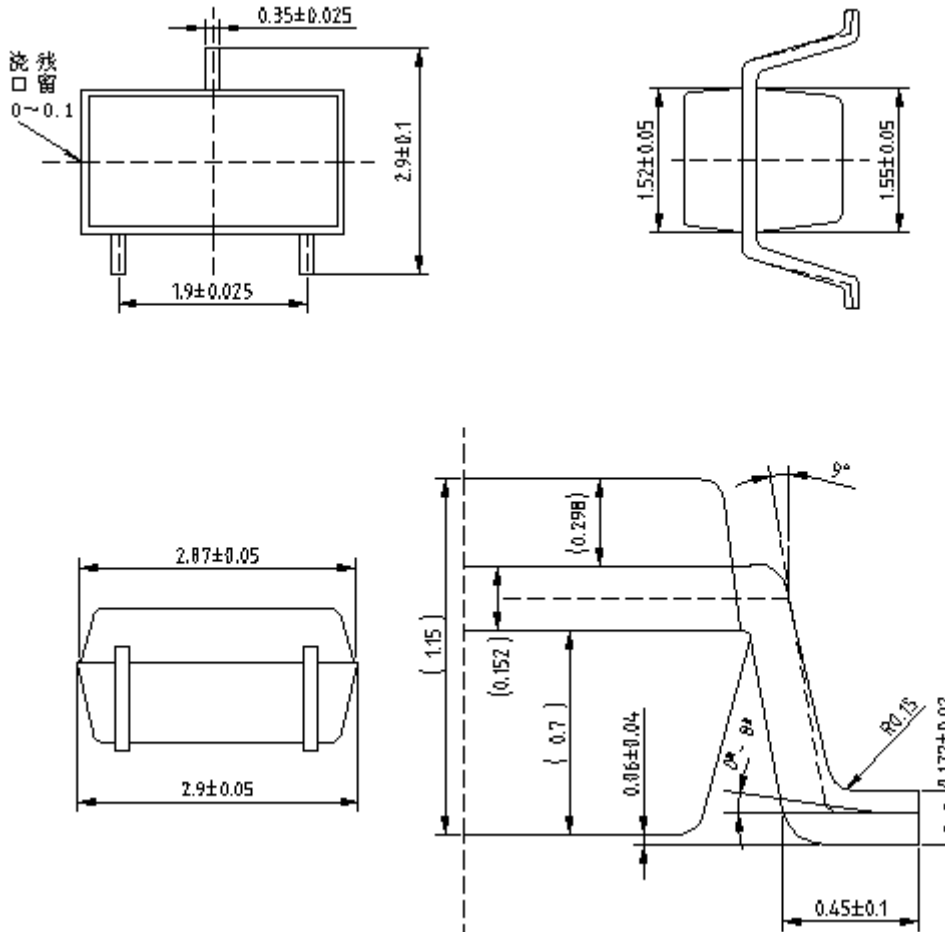

Figure 11: Normalized Maximum Transient Thermal Impedance



## SC-59 Carrier Tape

