

# DATA SHEET

**Product Name** Common Quality Anti-Sulfurized Chip Resistors

---

**Part Name** CQ Series

## Uniroyal Electronics Global Co., Ltd.

88 Longteng Road, Economic & Technical Development Zone, Kunshan, Jiangsu, China

Tel +86 512 5763 1411 / 22 /33

Email [marketing@uni-royal.cn](mailto:marketing@uni-royal.cn)

Manufacture Plant Uniroyal Electronics Industry (kunshan) co., ltd.  
Uniroyal Electronics Industry Co., Ltd.  
Uniroyal Electronics Global Co.,Ltd Shenzhen Branch  
Aeon Technology Corporation  
Uniroyal Electronics Global Co.,Ltd Xiamen Branch  
Kunshan Foss Electronic material Co., Ltd.

Brands *RoyalOhm* *UniOhm*



### 1. Scope

- 1.1 This specification for approve relates to the Common Quality Anti-Sulfurized Chip Resistors manufactured by UNI-ROYAL Application automobile.
- 1.2 The test items follow the test standard of AEC-Q200.
- 1.3 Anti-Sulfidation
- 1.4 Application car、IPAD、LED Lamps、 Intelligent home appliances , Medical equipment, Kinds of industrial control devices & industrial supplies

### 2. Part No. System

Part No. includes 14 codes shown as below:

2.1 1<sup>st</sup>~4<sup>th</sup> codes: Part name. E.g.: CQ01,CQ02,CQ03,CQ05,CQ06,CQ07,CQ10,CQ12

2.2 5<sup>th</sup>~6<sup>th</sup> codes: Power rating.

E.g.: W=Normal Size		“1~G” = “1~16”									
Wattage	1/32	3/4	1/2	1/3	1/4	1/8	1/10	1/16	1/20	1	
Normal Size	WH	07	W2	W3	W4	W8	WA	WG	WM	1W	

If power rating is lower or equal than 1 watt, 5<sup>th</sup> code would be “W” and 6<sup>th</sup> code would be a number or letter.

E.g.: WA=1/10W                      W4=1/4W

2.3 7<sup>th</sup> code: Tolerance. E.g.: D=±0.5% F=±1%                      G=±2%                      J=±5%                      K= ±10%

2.4 8<sup>th</sup>~11<sup>th</sup> codes: Resistance Value.

2.4.1 If value belongs to standard value of ≥5% series, 8<sup>th</sup> code would be zero, 9<sup>th</sup>~10<sup>th</sup> codes are significant figures of the resistance and 11<sup>th</sup> code is the power of ten.

2.4.2 If value belongs to standard value of ≤2% series, 8<sup>th</sup>~10<sup>th</sup> codes are significant figures of the resistance, and 11<sup>th</sup> code is the power of ten.

2.4.3 11<sup>th</sup> codes listed as following:

0=10<sup>0</sup>                      1=10<sup>1</sup>                      2=10<sup>2</sup>                      3=10<sup>3</sup>                      4=10<sup>4</sup>                      5=10<sup>5</sup>                      6=10<sup>6</sup>                      J=10<sup>-1</sup>                      K=10<sup>-2</sup>                      L=10<sup>-3</sup>                      M=10<sup>-4</sup>

2.5 12<sup>th</sup>~14<sup>th</sup> codes.

2.5.1 12<sup>th</sup> code: Packaging Type. E.g.: C=Bulk                      T=Tape/Reel

2.5.2 13<sup>th</sup> code: Standard Packing Quantity.

4=4000pcs                      5=5000pcs                      C=10000pcs                      D=20000pcs                      E=15000pcs

Chip Product: BD=B/B-20000pcs                      TC=T/R-10000pcs

2.5.3 14<sup>th</sup> code: Special features.

E = Environmental Protection, Lead Free, or Standard type.

### 3. Ordering Procedure

(Example: CQ05 1/8W ±5% 10K Ω T/R-5000 )

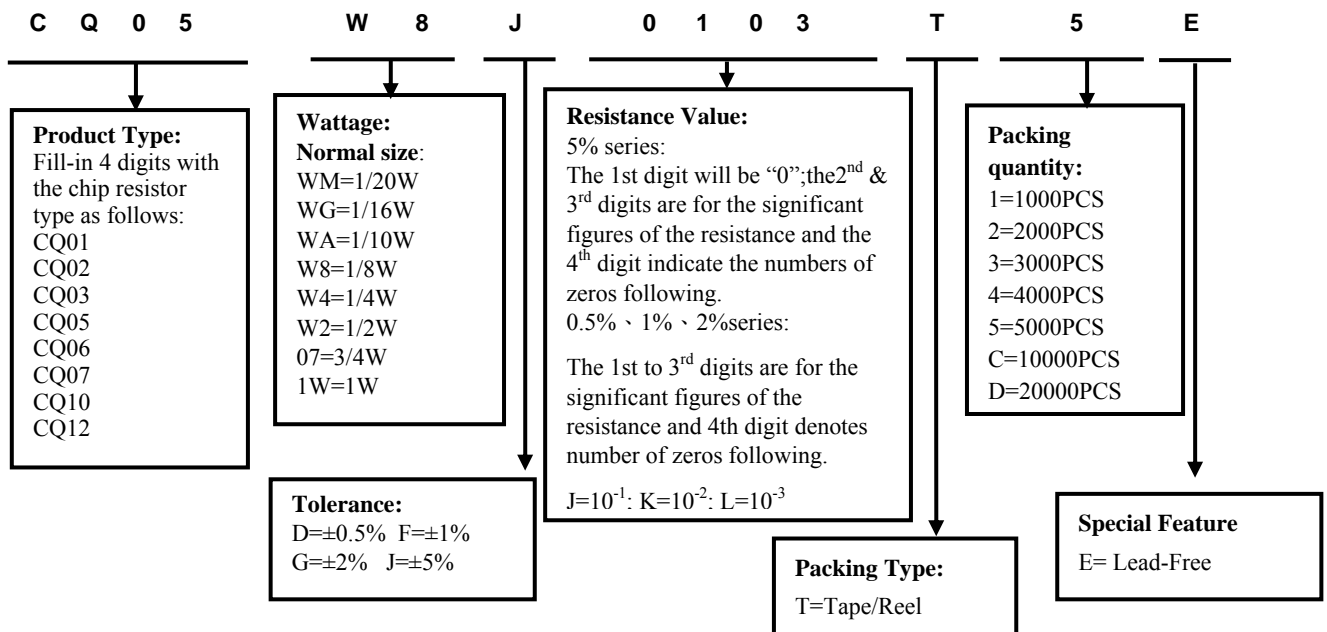

**4. Marking**

(1) Normally, the making of CQ01,CQ02 resistors as following



(2) Normally, the making of 0Ω CQ03, 0Ω CQ05, 0Ω CQ06, 0Ω CQ07, 0Ω CQ10, 0Ω CQ12, resistors as following



(3) ±5%Tolerance:The first two digits are significant figures of resistance and the third denotes number of zeros following



(4) ±1% Tolerance: 4 digits, first three digits are significant; fourth digit is number of zeros. Letter r is decimal point.



**5. Dimension**

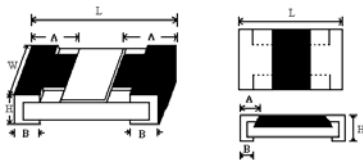

Type	Dimension(mm)				
	L	W	H	A	B
CQ01(0201)	0.60±0.03	0.30±0.03	0.23±0.03	0.12±0.05	0.15±0.05
CQ02(0402)	1.00±0.10	0.50±0.05	0.35±0.05	0.20±0.10	0.25±0.10
CQ03(0603)	1.60±0.10	0.80±0.10	0.45±0.10	0.30±0.20	0.30±0.20
CQ05(0805)	2.00±0.15	1.25 +0.15/-0.10	0.55±0.10	0.40±0.20	0.40±0.20
CQ06(1206)	3.10±0.15	1.55±0.15/-0.10	0.55±0.10	0.45±0.20	0.45±0.20
CQ07(1210)	3.10±0.10	2.60±0.20	0.55±0.10	0.50±0.25	0.50±0.20
CQ10(2010)	5.00±0.10	2.50±0.20	0.55±0.10	0.60±0.25	0.50±0.20
CQ12(2512)	6.35±0.10	3.20±0.20	0.55±0.10	0.60±0.25	0.50±0.20

**6. Resistance Range**

Type	Power Rating at 70°C	Resistance Range	
		1.0%	5.0%
CQ01	1/20W	1Ω-10MΩ	1Ω-10MΩ
CQ02	1/16W	1Ω-10MΩ	1Ω-10MΩ
CQ03	1/10W	1Ω-10MΩ	1Ω-10MΩ
CQ05	1/8W	1Ω-10MΩ	1Ω-10MΩ
CQ06	1/4W	1Ω-10MΩ	1Ω-10MΩ
CQ07	1/2W	1Ω-10MΩ	1Ω-10MΩ
CQ10	3/4W	1Ω-10MΩ	1Ω-10MΩ
CQ12	1W	1Ω-10MΩ	1Ω-10MΩ

**7. Ratings**

Type	Max. Working Voltage	Max. Overload Voltage	Dielectric withstanding Voltage	Resistance Value of Jumper	Rated Current of Jumper	Max. Overload Current of Jumper	Operating Temperature
CQ01	25V	50V	/	<50mΩ	0.5A	1A	-55°C~155°C
CQ02	50V	100V	100V	<50mΩ	1A	2A	-55°C~155°C
CQ03	75V	150V	300V	<50mΩ	1A	2A	-55°C~155°C
CQ05	150V	300V	500V	<50mΩ	2A	5A	-55°C~155°C
CQ06	200V	400V	500V	<50mΩ	2A	10A	-55°C~155°C
CQ07	200V	500V	500V	<50mΩ	2A	10A	-55°C~155°C
CQ10	200V	500V	500V	<50mΩ	2A	10A	-55°C~155°C
CQ12	200V	500V	500V	<50mΩ	2A	10A	-55°C~155°C

**8. Recommend the size of welding plate**

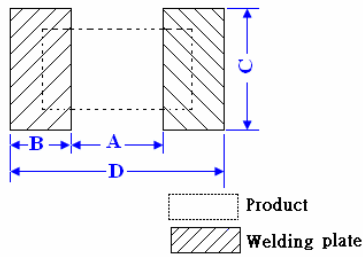

Type	Dimension(mm)			
	A	B	C	D
CQ01	0.3±0.05	0.35±0.05	0.4±0.05	1.0±0.05
CQ02	0.50±0.05	0.45±0.05	0.5±0.05	1.4±0.05
CQ03	0.8±0.05	0.65±0.05	0.8±0.05	2.1±0.05
CQ05	1.0±0.1	1.0±0.1	1.3±0.1	3.0±0.1
CQ06	2.0±0.1	1.1±0.1	1.6±0.1	4.2±0.1
CQ07	2.0±0.1	1.1±0.1	2.6±0.1	4.2±0.1
CQ10	3.6±0.1	1.3±0.1	2.6±0.1	6.2±0.1
CQ12	4.9±0.1	1.6±0.1	3.3±0.1	8.1±0.1

**9. Derating Curve**

Resistors shall have a power rating based on continuous load operation at an ambient temperature from -55°C to 70°C. For temperature in excess of 70°C, the load shall be derated as shown in figure 1

Figure 1

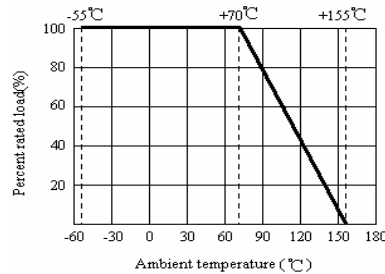

Voltage rating:

Resistors shall have a rated direct-current (DC) continuous working

Voltage or an approximate sine-wave root-mean-square (RMS) alternating-current (AC) continuous working voltage at commercial-line frequency and waveform corresponding to the power rating, as determined from the following formula:

$$RCWV = \sqrt{P \times R}$$

Where: RCWV commercial-line frequency and waveform (Volt.)

P = power rating (WATT.) R = nominal resistance (OHM)

In no case shall the rated DC or RMS AC continuous working voltage be greater than the applicable maximum value.

The overload voltage is 2.5 times RCWV or Max. Overload voltage whichever is less

**10. Structure**

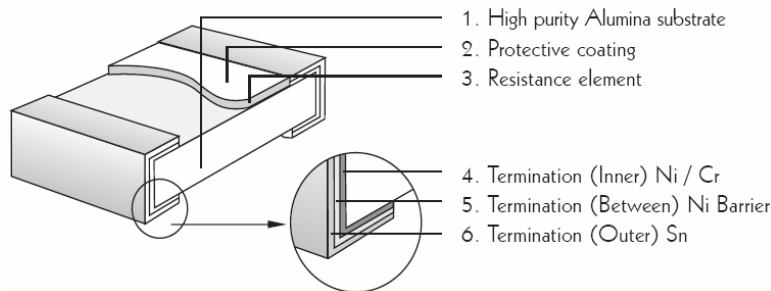

### 11. Performance Specification

Characteristic	Limits	Ref. Standards	Test Method
Operational life	±5%: ±(3%+0.1Ω)Max. ±1%: ±(1%+0.1Ω)Max.	MIL-STD-202	125°C, at 36% of operating power, 1000H(1.5 hours "ON", 0.5 hour "OFF").
	<100mΩ		Apply to rate current for 0 Ω
Electrical Characterization	1Ω ≤ R ≤ 10Ω: ≤ ±400PPM/°C 10Ω < R ≤ 100Ω: ≤ ±200PPM/°C 100Ω < R ≤ 10MΩ: ≤ ±100PPM/°C CQ01: 10Ω < R ≤ 10MΩ: ±200PPM/°C	User Spec	Parametrically test per lot and sample size requirements, summary to show Min, Max, Mean and Standard deviation at room as well as Min and Max operating temperatures.
Short-time overload	±1%: ±(1%+0.1Ω) Max. ±5%: ±(2%+0.1Ω) Max.	JIS-C-5201	4.13 Permanent resistance change after the application of a potential of 2.5 times RCWV or Max. Overload Voltage whichever less for 5 seconds..
	<50mΩ		Apply max Overload current for 0Ω
External Visual	No Mechanical Damage	MIL-STD-883 Method 2009	Electrical test not required. Inspect device construction, marking and workmanship
Physical Dimension	Reference 2.0 Dimension Standards	JESD22 MH Method JB-100	Verify physical dimensions to the applicable device detail specification. Note: User(s) and Suppliers spec. Electrical test not required.
Resistance to Solvent	Marking Unsmearred	MIL-STD-202 Method 215	Note: Add Aqueous wash chemical – OKEM Clean or equivalent. Do not use banned solvents.
Terminal Strength	Not broken	JIS-C-6429	Force of 1.8kg for 60 seconds.
High Temperature Exposure (Storage)	±(1%+0.1Ω)Max.	MIL-STD-202 Method 108	1000hrs. @T=155°C. Unpowered. Measurement at 24±2 hours after test conclusion.
	<50mΩ		Apply to rate current for 0 Ω
Temperature Cycling	±(1%+0.1Ω)Max.	JESD22 Method JA-104	1000 Cycles (-55°C to +155°C). Measurement at 24±2 hours after test conclusion.
	<50mΩ		Apply to rate current for 0 Ω
Biased Humidity	±5%: ±(3%+0.1Ω)Max. ±1%: ±(1%+0.1Ω)Max..	MIL-STD-202 Method 103	1000 hours 85°C, 85%RH. Note: Specified conditions: 10% of operating power. Measurement at 24±2 hours after test conclusion.
	<100mΩ		Apply to rate current for 0 Ω
Mechanical Shock	±(1%+0.1Ω)Max.	MIL-STD-202 Method 213	Wave Form: Tolerance for half sine shock pulse. Peak value is 100g's. Normal duration (D) is 6.
Vibration	±(1%+0.1Ω)Max.	MIL-STD-202 Method 204	5g's for 20 min., 12cycle each of 3 orientations. Note: Use 8''*5''PCB. 031'' thick 7 secure points on one long side and 2 secure points at corners of opposite sides. Parts mounted within 2' from any secure point. Test from 10-2000Hz.
ESD	±(1%+0.1Ω)Max.	AEC-Q200-002	With the electrometer in direct contact with the discharge tip, verify the voltage setting at levels of ±500V, ±1KV, ±2KV, ±4KV, ±8KV, The electrometer reading shall be within ±10% for voltages from 500V to ≤800V.
Solderability	95% coverage Min.	J-STD-002	For both leaded & SMD. Electrical test not required. Magnification 50X. Conditions: a) Method B 4hrs at 155°C dry heat, the dip in bath with 245°C, 5s. b) Method B: at 215°C, 5s. c) Method D: at 260°C, 60s.
Board Flex	±(1%+0.05Ω)Max.	JIS-C-6429	2mm (Min)
	<50mΩ		Apply to rate current for 0 Ω
Resistance to Soldering Heat	±(1%+0.05Ω)Max.	MIL-STD-202 Method 210	Condition B No per-heat of samples. Note: Single Wave Solder-Procedure 2 for SMD and Procedure 1 for Leaded with solder within 1.5mm of device body.
	<50mΩ		Apply to rate current for 0 Ω

Sulfuration test: H<sub>2</sub>S 3~5PPM 50°C ±2°C 91%~93%RH 1000H

±5%:(5.0%+0.1 Ω)Max ; ±1%:(1.0%+0.1 Ω)Max

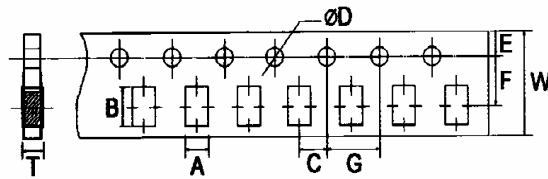
**12. Packing of Surface Mount Resistors**
**12.1 Dimension of Paper Taping : (Unit: mm)**

Type	A	B	C ±0.05	$\begin{matrix} +0.1 \\ \Phi D \\ -0 \end{matrix}$	E ±0.1	F ±0.05	G ±0.1	W ±0.2	T
CQ01	0.40±0.05	0.70±0.05	2.00	1.50	1.75	3.50	4.00	8.00	0.42±0.1
CQ02	0.65±0.1	1.20±0.1	2.00	1.50	1.75	3.50	4.00	8.00	0.42±0.05

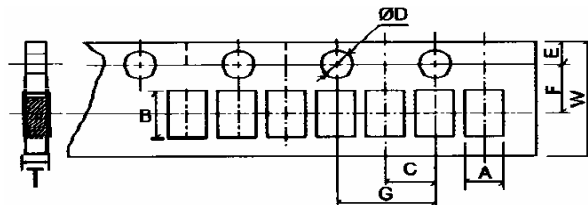

Type	A ±0.2	B ±0.2	C ±0.05	$\begin{matrix} +0.1 \\ \Phi D \\ -0 \end{matrix}$	E ±0.1	F ±0.05	G ±0.1	W ±0.2	T ±0.1
CQ03	1.10	1.90	2.00	1.50	1.75	3.50	4.00	8.00	0.67
CQ05	1.65	2.40	2.00	1.50	1.75	3.50	4.00	8.00	0.81
CQ06	2.00	3.60	2.00	1.50	1.75	3.50	4.00	8.00	0.81
CQ07	2.80	3.50	2.00	1.50	1.75	3.50	4.00	8.00	0.75

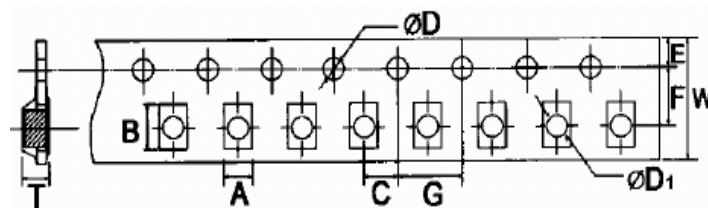
**12.2 Dimension of Embossed Taping: (Unit: mm)**

Type	A ±0.2	B ±0.2	C ±0.05	$\begin{matrix} +0.1 \\ \phi D \\ -0 \end{matrix}$	$\begin{matrix} +0.25 \\ \phi D1 \\ -0 \end{matrix}$	E ±0.1	F ±0.05	G ±0.1	W ±0.2	T ±0.1
CQ10	2.90	5.60	2.00	1.50	1.50	1.75	5.50	4.00	12.00	1.00
CQ12	3.50	6.70	2.00	1.50	1.50	1.75	5.50	4.00	12.00	1.00

12.3 Dimension of Reel : (Unit: mm)

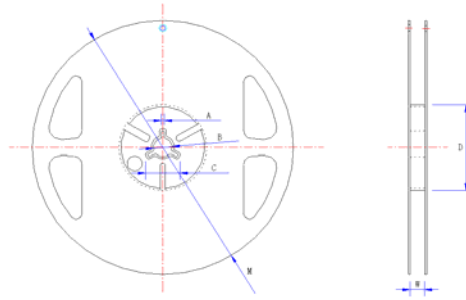

Type	Taping	Qty/Reel	A±0.5	B±0.5	C±0.5	D±1	M±2	W±1
CQ01	Paper	10,000pcs	2.0	13.0	21.0	60.0	178.0	10.0
CQ02	Paper	10,000pcs	2.0	13.0	21.0	60.0	178.0	10.0
CQ03	Paper	5,000pcs	2.0	13.0	21.0	60.0	178.0	10.0
CQ05	Paper	5,000pcs	2.0	13.0	21.0	60.0	178.0	10.0
CQ06	Paper	5,000pcs	2.0	13.0	21.0	60.0	178.0	10.0
CQ07	Paper	5,000pcs	2.0	13.0	21.0	60.0	178.0	10.0
CQ10	Embossed	4,000pcs	2.0	13.0	21.0	60.0	178.0	13.8
CQ12	Embossed	4,000pcs	2.0	13.0	21.0	60.0	178.0	13.8

**13. Note**

- 13.1. UNI-ROYAL recommend the storage condition temperature: 15°C~35°C, humidity :25%~75%.  
 (Put condition for individual product).Even under UNI-ROYAL recommended storage condition, solderability of products over 1 year old.  
 (Put condition for each product) may be degraded.
- 13.2. Store / transport cartons in the correct direction, which is indicated on a carton as a symbol.  
 Otherwise bent leads may occur due to excessive stress applied when dropping of a carton.
- 13.3. Product performance and soldered connections may deteriorate if the products are stored in the following places:
  - a. Storage in high Electrostatic.
  - b. Storage in direct sunshine 、rain and snow or condensation.

**14. Record**

Version	Description of amendment	Page	Date	Amended by	Checked by
1	First issue of this specification	1~7	Mar.20, 2018	Chen Haiyan	Chen Nana

Uniroyal Electronics Global Co., Ltd. , all rights reserved. Spec. herein would be changed at any time without prior notice.

# DATA SHEET

**Product Name** Automotive Thick Film Chip Resistors

---

**Part Name** CQ Series

## Uniroyal Electronics Global Co., Ltd.

88 Longteng Road, Economic & Technical Development Zone, Kunshan, Jiangsu, China

Tel +86 512 5763 1411 / 22 /33

Email [marketing@uni-royal.cn](mailto:marketing@uni-royal.cn)

Manufacture Plant Uniroyal Electronics Industry (kunshan) co., ltd.  
Uniroyal Electronics Industry Co., Ltd.  
Uniroyal Electronics Global Co.,Ltd Shenzhen Branch  
Aeon Technology Corporation  
Uniroyal Electronics Global Co.,Ltd Xiamen Branch  
Kunshan Foss Electronic material Co., Ltd.

Brands *RoyalOhm* *UniOhm*





**1. Scope**

- 1.1 This specification for approve relates to the Automotive Thick Film Chip Resistors manufactured by UNI-ROYAL Application automobile.
- 1.2The test items follow the test standard of AEC-Q200.
- 1.3Anti-Sulfidation
- 1.4 Application car、IPAD、LED Lamps、 Intelligent home appliances , Medical equipment, Kinds of industrial control devices & industrial supplies

**2. Part No. System**

Part No. includes 14 codes shown as below:

2.1 1<sup>st</sup>~4<sup>th</sup> codes: Part name. E.g.: CQ01,CQ02,CQ03,CQ05,CQ06,CQ07,CQ10,CQ12

2.2 5<sup>th</sup>~6<sup>th</sup> codes: Power rating.

E.g.: W=Normal Size                      "1~G" = "1~16"

Wattage	1/32	3/4	1/2	1/3	1/4	1/8	1/10	1/16	1/20	1
Normal Size	WH	07	W2	W3	W4	W8	WA	WG	WM	1W

If power rating is lower or equal than 1 watt, 5<sup>th</sup> code would be "W" and 6<sup>th</sup> code would be a number or letter.

E.g.: WA=1/10W                      W4=1/4W

2.3 7<sup>th</sup> code: Tolerance. E.g.: D=±0.5% F=±1%                      G=±2%                      J=±5%                      K= ±10%

2.4 8<sup>th</sup>~11<sup>th</sup> codes: Resistance Value.

2.4.1 If value belongs to standard value of ≥5% series, 8<sup>th</sup> code would be zero,9<sup>th</sup>~10<sup>th</sup> codes are significant figures of the resistance and 11<sup>th</sup> code is the power of ten.

2.4.2 If value belongs to standard value of ≤2% series, 8<sup>th</sup>~10<sup>th</sup> codes are significant figures of the resistance, and 11<sup>th</sup> code is the power of ten.

2.4.3 11<sup>th</sup> codes listed as following:

0=10<sup>0</sup>                      1=10<sup>1</sup>                      2=10<sup>2</sup>                      3=10<sup>3</sup>                      4=10<sup>4</sup>                      5=10<sup>5</sup>                      6=10<sup>6</sup>                      J=10<sup>-1</sup>                      K=10<sup>-2</sup>                      L=10<sup>-3</sup>                      M=10<sup>-4</sup>

2.5 12<sup>th</sup>~14<sup>th</sup> codes.

2.5.1 12<sup>th</sup> code: Packaging Type. E.g.: C=Bulk                      T=Tape/Reel

2.5.2 13<sup>th</sup> code: Standard Packing Quantity.

4=4000pcs                      5=5000pcs                      C=10000pcs                      D=20000pcs                      E=15000pcs

Chip Product: BD=B/B-20000pcs                      TC=T/R-10000pcs

2.5.3 14<sup>th</sup> code: Special features.

E = Environmental Protection, Lead Free, or Standard type.

**3. Ordering Procedure**

(Example: CQ05 1/8W ±5% 10K Ω T/R-5000 )

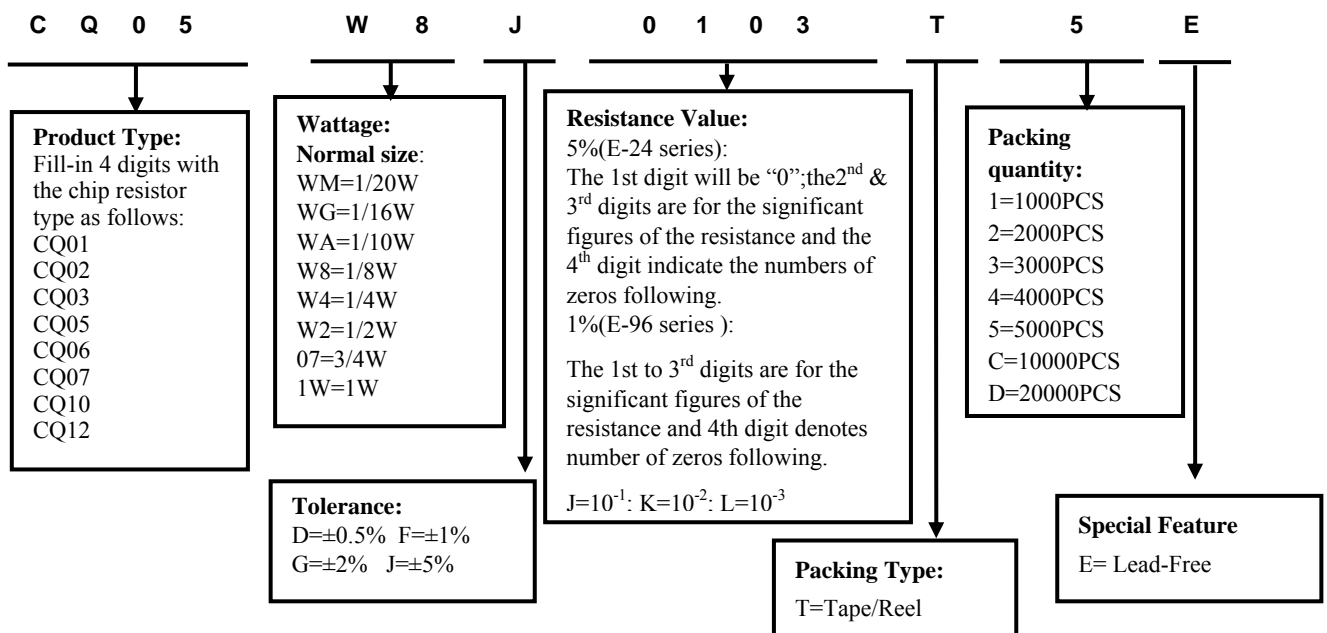

**4. Marking**

(1) Normally, the making of CQ01,CQ02 resistors as following



(2) Normally, the making of 0Ω CQ03, 0Ω CQ05, 0Ω CQ06, 0Ω CQ07, 0Ω CQ10, 0Ω CQ12, resistors as following



(3) ±5%Tolerance: The first two digits are significant figures of resistance and the third denotes number of zeros following



(4) ±1% Tolerance: 4 digits, first three digits are significant; fourth digit is number of zeros. Letter r is decimal point.



**5. Dimension**

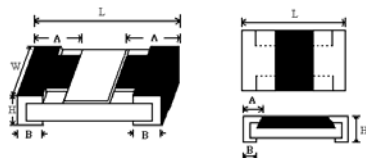

Type	Dimension(mm)				
	L	W	H	A	B
CQ01(0201)	0.60±0.03	0.30±0.03	0.23±0.03	0.12±0.05	0.15±0.05
CQ02(0402)	1.00±0.10	0.50±0.05	0.35±0.05	0.20±0.10	0.25±0.10
CQ03(0603)	1.60±0.10	0.80±0.10	0.45±0.10	0.30±0.20	0.30±0.20
CQ05(0805)	2.00±0.15	1.25 +0.15/-0.10	0.55±0.10	0.40±0.20	0.40±0.20
CQ06(1206)	3.10±0.15	1.55+0.15/-0.10	0.55±0.10	0.45±0.20	0.45±0.20
CQ07(1210)	3.10±0.10	2.60±0.20	0.55±0.10	0.50±0.25	0.50±0.20
CQ10(2010)	5.00±0.10	2.50±0.20	0.55±0.10	0.60±0.25	0.50±0.20
CQ12(2512)	6.35±0.10	3.20±0.20	0.55±0.10	0.60±0.25	0.50±0.20

**6. Resistance Range**

Type	Power Rating at 70°C	Resistance Range	
		1.0%	5.0%
CQ01	1/20W	1Ω-10MΩ	1Ω-10MΩ
CQ02	1/16W	1Ω-10MΩ	1Ω-10MΩ
CQ03	1/10W	1Ω-10MΩ	1Ω-10MΩ
CQ05	1/8W	1Ω-10MΩ	1Ω-10MΩ
CQ06	1/4W	1Ω-10MΩ	1Ω-10MΩ
CQ07	1/2W	1Ω-10MΩ	1Ω-10MΩ
CQ10	3/4W	1Ω-10MΩ	1Ω-10MΩ
CQ12	1W	1Ω-10MΩ	1Ω-10MΩ

**7. Ratings**

Type	Max. Working Voltage	Max. Overload Voltage	Dielectric withstanding Voltage	Resistance Value of Jumper	Rated Current of Jumper	Max. Overload Current of Jumper	Operating Temperature
CQ01	25V	50V	/	<50mΩ	0.5A	1A	-55°C~155°C
CQ02	50V	100V	100V	<50mΩ	1A	2A	-55°C~155°C
CQ03	75V	150V	300V	<50mΩ	1A	2A	-55°C~155°C
CQ05	150V	300V	500V	<50mΩ	2A	5A	-55°C~155°C
CQ06	200V	400V	500V	<50mΩ	2A	10A	-55°C~155°C
CQ07	200V	500V	500V	<50mΩ	2A	10A	-55°C~155°C
CQ10	200V	500V	500V	<50mΩ	2A	10A	-55°C~155°C
CQ12	200V	500V	500V	<50mΩ	2A	10A	-55°C~155°C

**8. Recommend the size of welding plate**

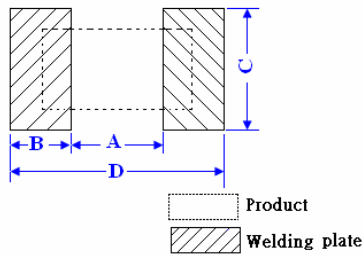

Type	Dimension(mm)			
	A	B	C	D
CQ01	0.3±0.05	0.35±0.05	0.4±0.05	1.0±0.05
CQ02	0.50±0.05	0.45±0.05	0.5±0.05	1.4±0.05
CQ03	0.8±0.05	0.65±0.05	0.8±0.05	2.1±0.05
CQ05	1.0±0.1	1.0±0.1	1.3±0.1	3.0±0.1
CQ06	2.0±0.1	1.1±0.1	1.6±0.1	4.2±0.1
CQ07	2.0±0.1	1.1±0.1	2.6±0.1	4.2±0.1
CQ10	3.6±0.1	1.3±0.1	2.6±0.1	6.2±0.1
CQ12	4.9±0.1	1.6±0.1	3.3±0.1	8.1±0.1

**9. Derating Curve**

Resistors shall have a power rating based on continuous load operation at an ambient temperature from -55°C to 70°C. For temperature in excess of 70°C, the load shall be derated as shown in figure 1

Figure 1

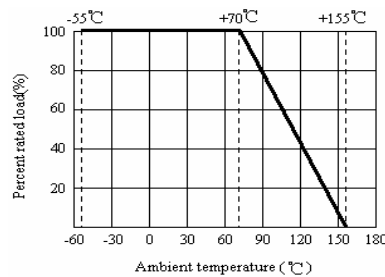

Voltage rating:

Resistors shall have a rated direct-current (DC) continuous working

voltage or an approximate sine-wave root-mean-square (RMS) alternating-current (AC) continuous working voltage at commercial-line frequency and waveform corresponding to the power rating, as determined from the following formula:

$$RCWV = \sqrt{P \times R}$$

Where: RCWV commercial-line frequency and waveform (Volt.)

P = power rating (WATT.) R = nominal resistance (OHM)

In no case shall the rated DC or RMS AC continuous working voltage be greater than the applicable maximum value.

The overload voltage is 2.5 times RCWV or Max. Overload voltage whichever is less

**10. Structure**

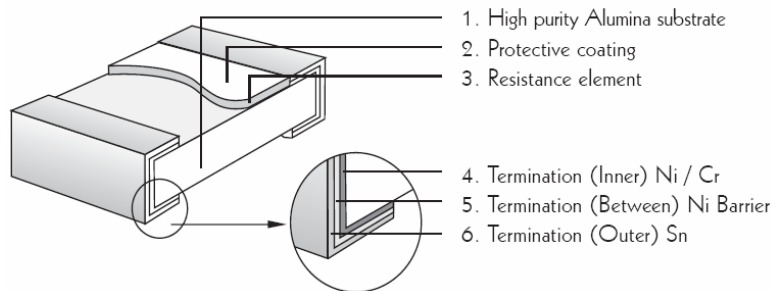

**11. Performance Specification**

Characteristic	Limits	Ref. Standards	Test Method
Operational life	$\pm 5\%: \pm(3\%+0.1\Omega)\text{Max.}$ $\pm 1\%: \pm(1\%+0.1\Omega)\text{Max.}$	MIL-STD-202	125°C, at 36% of operating power, 1000H(1.5 hours "ON", 0.5 hour "OFF").
	<100mΩ		Apply to rate current for 0 Ω
Electrical Characterization	1Ω ≤ R ≤ 10Ω: ≤ ±400PPM/°C 10Ω < R ≤ 100Ω: ≤ ±200PPM/°C 100Ω < R ≤ 10MΩ: ≤ ±100PPM/°C CQ01: 10Ω < R ≤ 10MΩ: ±200PPM/°C	User Spec	Parametrically test per lot and sample size requirements, summary to show Min, Max, Mean and Standard deviation at room as well as Min and Max operating temperatures.
Short-time overload	$\pm 1\%: \pm(1\%+0.1\Omega)\text{ Max.}$ $\pm 5\%: \pm(2\%+0.1\Omega)\text{ Max.}$	JIS-C-5201	4.13 Permanent resistance change after the application of a potential of 2.5 times RCWV or Max. Overload Voltage whichever less for 5 seconds..
	<50mΩ		Apply max Overload current for 0Ω
External Visual	No Mechanical Damage	MIL-STD-883 Method 2009	Electrical test not required. Inspect device construction, marking and workmanship
Physical Dimension	Reference 2.0 Dimension Standards	JESD22 MH Method JB-100	Verify physical dimensions to the applicable device detail specification. Note: User(s) and Suppliers spec. Electrical test not required.
Resistance to Solvent	Marking Unsmearred	MIL-STD-202 Method 215	Note: Add Aqueous wash chemical – OKEM Clean or equivalent. Do not use banned solvents.
Terminal Strength	Not broken	JIS-C-6429	Force of 1.8kg for 60 seconds.
High Temperature Exposure (Storage)	$\pm(1\%+0.1\Omega)\text{Max.}$	MIL-STD-202 Method 108	1000hrs. @T=155°C. Unpowered. Measurement at 24±2 hours after test conclusion.
	<50mΩ		Apply to rate current for 0 Ω
Temperature Cycling	$\pm(1\%+0.1\Omega)\text{Max.}$	JESD22 Method JA-104	1000 Cycles (-55°C to +155°C). Measurement at 24±2 hours after test conclusion.
	<50mΩ		Apply to rate current for 0 Ω
Biased Humidity	$\pm 5\%: \pm(3\%+0.1\Omega)\text{Max.}$ $\pm 1\%: \pm(1\%+0.1\Omega)\text{Max.}$	MIL-STD-202 Method 103	1000 hours 85°C, 85%RH. Note: Specified conditions: 10% of operating power. Measurement at 24±2 hours after test conclusion.
	<100mΩ		Apply to rate current for 0 Ω
Mechanical Shock	$\pm(1\%+0.1\Omega)\text{Max.}$	MIL-STD-202 Method 213	Wave Form: Tolerance for half sine shock pulse. Peak value is 100g's. Normal duration (D) is 6.
Vibration	$\pm(1\%+0.1\Omega)\text{Max.}$	MIL-STD-202 Method 204	5g's for 20 min., 12cycle each of 3 orientations. Note: Use 8"×5" PCB. 031" thick 7 secure points on one long side and 2 secure points at corners of opposite sides. Parts mounted within 2' from any secure point. Test from 10-2000Hz.
ESD	$\pm(1\%+0.1\Omega)\text{Max.}$	AEC-Q200-002	With the electrometer in direct contact with the discharge tip, verify the voltage setting at levels of ±500V, ±1KV, ±2KV, ±4KV, ±8KV, The electrometer reading shall be within ±10% for voltages from 500V to ≅ 800V.
Solderability	95% coverage Min.	J-STD-002	For both leaded & SMD. Electrical test not required. Magnification 50X. Conditions: a) Method B 4hrs at 155°C dry heat, the dip in bath with 245°C, 5s. b) Method B: at 215°C, 5s. c) Method D: at 260°C, 60s.
Flammability	No ignition of the tissue paper or scorching or the pinewood board	UL-94	V-0 or V-1 are acceptable. Electrical test not required.
Board Flex	$\pm(1\%+0.05\Omega)\text{Max.}$	JIS-C-6429	2mm (Min)
	<50mΩ		Apply to rate current for 0 Ω
Flame Retardance	No flame	AEC-Q200-001	Only requested, when voltage/power will increase the surface temp to 350°C. Apply voltage from 9V to 32V. No flame; No explosion.

Resistance to Soldering Heat

$\pm(1\%+0.05\Omega)\text{Max.}$

$<50\text{m}\Omega$

MIL-STD-202 Method 210

Condition B No per-heat of samples. Note: Single Wave Solder-Procedure 2 for SMD and Procedure 1 for Leaded with solder within 1.5mm of device body.

Apply to rate current for 0  $\Omega$

Sulfuration test:  $\text{H}_2\text{S}$  3~5PPM  $50^\circ\text{C}\pm 2^\circ\text{C}$  91%~93%RH 1000H

$\pm 5\%:(5.0\%+0.1\Omega)\text{Max}$  ;  $\pm 1\%:(1.0\%+0.1\Omega)\text{Max}$

**12. Packing of Surface Mount Resistors**

12.1 Dimension of Paper Taping :(Unit: mm)

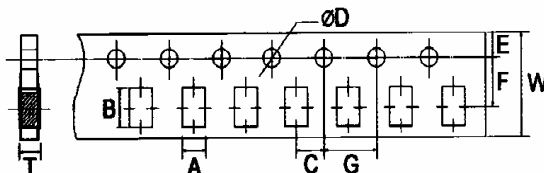

Type	A	B	C $\pm 0.05$	$\begin{matrix} +0.1 \\ \Phi D \\ -0 \end{matrix}$	E $\pm 0.1$	F $\pm 0.05$	G $\pm 0.1$	W $\pm 0.2$	T
CQ01	0.40 $\pm$ 0.05	0.70 $\pm$ 0.05	2.00	1.50	1.75	3.50	4.00	8.00	0.42 $\pm$ 0.1
CQ02	0.65 $\pm$ 0.1	1.20 $\pm$ 0.1	2.00	1.50	1.75	3.50	4.00	8.00	0.42 $\pm$ 0.05

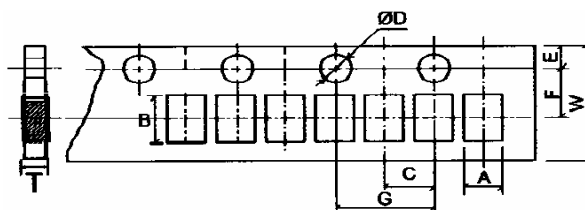

Type	A $\pm 0.2$	B $\pm 0.2$	C $\pm 0.05$	$\begin{matrix} +0.1 \\ \Phi D \\ -0 \end{matrix}$	E $\pm 0.1$	F $\pm 0.05$	G $\pm 0.1$	W $\pm 0.2$	T $\pm 0.1$
CQ03	1.10	1.90	2.00	1.50	1.75	3.50	4.00	8.00	0.67
CQ05	1.65	2.40	2.00	1.50	1.75	3.50	4.00	8.00	0.81
CQ06	2.00	3.60	2.00	1.50	1.75	3.50	4.00	8.00	0.81
CQ07	2.80	3.50	2.00	1.50	1.75	3.50	4.00	8.00	0.75

12.2 Dimension of Embossed Taping: (Unit: mm)

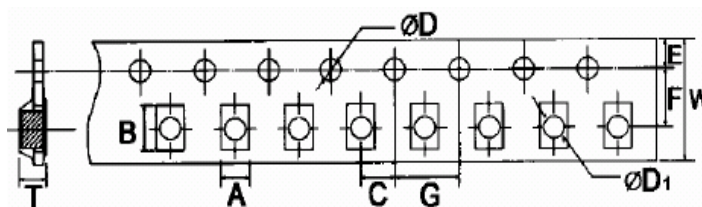

Type	A $\pm 0.2$	B $\pm 0.2$	C $\pm 0.05$	$\begin{matrix} +0.1 \\ \phi D \\ -0 \end{matrix}$	$\begin{matrix} +0.25 \\ \phi D1 \\ -0 \end{matrix}$	E $\pm 0.1$	F $\pm 0.05$	G $\pm 0.1$	W $\pm 0.2$	T $\pm 0.1$
CQ10	2.90	5.60	2.00	1.50	1.50	1.75	5.50	4.00	12.00	1.00
CQ12	3.50	6.70	2.00	1.50	1.50	1.75	5.50	4.00	12.00	1.00

12.3 Dimension of Reel : (Unit: mm)

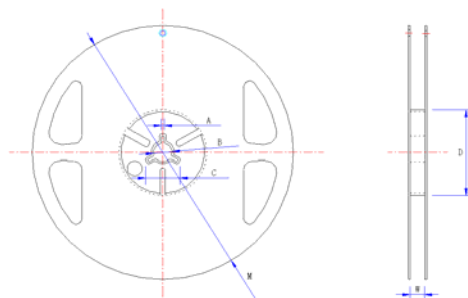

Type	Taping	Qty/Reel	A±0.5	B±0.5	C±0.5	D±1	M±2	W±1
CQ01	Paper	10,000pcs	2.0	13.0	21.0	60.0	178.0	10.0
CQ02	Paper	10,000pcs	2.0	13.0	21.0	60.0	178.0	10.0
CQ03	Paper	5,000pcs	2.0	13.0	21.0	60.0	178.0	10.0
CQ05	Paper	5,000pcs	2.0	13.0	21.0	60.0	178.0	10.0
CQ06	Paper	5,000pcs	2.0	13.0	21.0	60.0	178.0	10.0
CQ07	Paper	5,000pcs	2.0	13.0	21.0	60.0	178.0	10.0
CQ10	Embossed	4,000pcs	2.0	13.0	21.0	60.0	178.0	13.8
CQ12	Embossed	4,000pcs	2.0	13.0	21.0	60.0	178.0	13.8

**13. Note**

- 13.1. UNI-ROYAL recommend the storage condition temperature: 15°C~35°C, humidity :25%~75%.  
 (Put condition for individual product).Even under UNI-ROYAL recommended storage condition, solderability of products over 1 year old.  
 (Put condition for each product) may be degraded.
- 13.2. Store / transport cartons in the correct direction, which is indicated on a carton as a symbol.  
 Otherwise bent leads may occur due to excessive stress applied when dropping of a carton.
- 13.3. Product performance and soldered connections may deteriorate if the products are stored in the following places:
  - a. Storage in high Electrostatic.
  - b. Storage in direct sunshine 、rain and snow or condensation.

**14. Record**

Version	Description of amendment	Page	Date	Amended by	Checked by
1	First issue of this specification	1~7	Mar.20, 2018	Chen Haiyan	Chen Nana
2	Modify the product name	1~7	Nov.22, 2018	Chen Haiyan	Chen Nana

Uniroyal Electronics Global Co., Ltd. , all rights reserved. Spec. herein would be changed at any time without prior notice.